

DFC 17B, 27B: Heavy-duty pressure switch

How energy efficiency is improved

Demand-led controlling and monitoring; no external energy source required.

Areas of application

For regulating and monitoring pressures in liquids, gases and vapours. Especially suitable for equipment that is subject to vibrations.

Features

- Pressure range: -1 to +50 bar
- Contact rating: 1 mA, 6 V to 10 A, 400 V
- Up to 110 °C media temperature
- Gold-plated silver contacts, vibration-proof snap-action switch with single-pole change-over switch
- Upper and lower switching points can be set independently
- Sealable
- As per PED (Pressure Equipment Directive) 97/23/EC, Cat. IV

Technical description

- Light-alloy housing with transparent cover
- Splash-proof
- Ambient temperature: -40 to +70 °C
- IP 44
- Brass sensor or stainless-steel for aggressive media, G ½", male thread, screw terminals for electrical conductor max. 2.5 mm², cable inlet PG 13.5



T03514

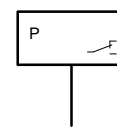

Y03262

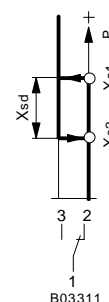

B03311

Type	Setting range bar	Min. switching diff. bar	Max. sensor values bar	Max. sensor values °C	Weight kg
Pressure sensor of brass for non-aggressive media					
DFC 17B54 F001	0...2,5	0,14	16	70	1,2
DFC 17B58 F001	0...6,0	0,18	16	70	1,2
DFC 17B59 F001	-1,0...5,0	0,20	16	70	1,2
DFC 17B76 F001	0...10	0,5	40	70	1,1
DFC 17B78 F001	0...16	0,5	40	70	1,1
DFC 17B79 F001	16...32	0,8	42	70	1,1
DFC 17B96 F001	0...25	1,7	100	70	1,0
DFC 17B97 F001	25...50	2,0	100	70	1,0
DFC 17B98 F001	0...40	1,8	100	70	1,0
Pressure sensor of stainless steel for aggressive media					
DFC 27B26 F002	-1,0...2,5	0,3	21	110	0,9
DFC 27B43 F002	0,5...6,0	0,3	21	110	0,9
DFC 27B46 F002	1,0...10	0,3	21	110	0,9
DFC 27B52 F002	2,0...16	0,3	21	110	0,9

Contact rating	Degree of protection	IP 44 (EN 60529) ³⁾	
as silver contacts ¹⁾ for higher loading	Protection class	I (IEC 60730)	
max.	Test marking ⁴⁾		
	DWFS (SDBF)	ID: 0000006018	
	DWFS (SDB)	ID: 0000006019	
	DB (SDBF)	ID: 0000006017	
	PED	Cat. IV	
min.		DFC 17	DFC 27
as gold contacts ²⁾ for lower loading	Wiring diagram	A01499	A01499
max.	Dimension drawing	M259344	M259344
min.	Fitting instructions	MV 2275	MV 2284
Permissible vacuum loading			
Type B30; B54			
Permissible ambient temp.			

1) If under inductive load, take RC circuit into account

2) If the contacts are ever loaded higher than 200 mA, 50 V, the gold plating will be damaged. The contacts are then classed only as silver contacts, since they lose the properties of gold contacts

3) IP 54 with accessory 0233310 000

4) Certificates can be downloaded from www.tuv.com

5) 230/400 V networks

6) From 70 °C media temperature, the current must be reduced to 6 A.



Accessories

0044529 000	Plug spanner for the setting screws.
0192222 000*	Cap nut with soldering nipple.
0259239 000*	Adaptor G½ to 7/16" 20-UNF-2A for connecting copper tubing of Ø 6 mm, brass.
0311572 000*	Screw connection for connecting copper tubes of Ø 6 mm, brass.
0035465 000	Throttling screw for damping pressure surges; brass.
0214120 000	Throttling screw for damping pressure surges; stainless steel.
0192700 000*	1 m of capillary tubing for damping pressure surges; copper.
0114467 000*	1 m of capillary tubing for damping pressure surges; steel.
0292018 001*	Damping screw for arresting pressure surges in low-viscosity media. Stainless steel.
0259189 000*	Bracket for off-wall mounting (already supplied with DFC 17 B 54...59).
0259409 000*	Bracket (for 3-point fixing when used with 0259189).
0259299 000	Cable screw fitting PG 13.5
0292019 001	Setpoint setting per switching point according to customer's specification (\pm 3% of the setting range).
0292019 002	Sealed set screw for each switching point (with accessory 0292019/001 only)
0381141 001*	Sealing ring of copper for G½"

*) Dimension drawing or wiring diagram are available under the same number

Operation

Whenever the pressure exceeds the upper switching point (which can be set on the right-hand scale), the contacts switch over from 1-2 to 1-3.

When the pressure falls below the lower switching point (which can be set on the left-hand scale), the contacts switch over from 1-3 to 1-2.

The vibration-proof snap-action switch has a pre-loaded spring which prevents the change-over mechanism from operating until the switching point has been attained. This ensures that the contacts remain fully closed right up to the switching point, even if operation is very slow.

Engineering and fitting notes

The pressure limiters conform to European regulation 97/23/EEC on pressure equipment and, as safety components, belong to equipment category IV. They are permitted for liquid combustibles and heat transfer oils. The devices also conform to Low-Voltage Directive 2006/95/EC and EMC Directive 2004/108/EC.

These devices can be employed as safety pressure limiters (SDBF) for falling pressure if an electric interlock circuit (see examples of use) is used and the requirements in EN 50156-1 have been fulfilled. The electrical equipment must comply with VDE 0660 or VDE 0435.

Types with TÜV approval as pressure controller for steam generators and hot-water boilers:

DFC 17 B54...98 F001

DFC 17 B54, 58, 78, 79 F001 with external electric locking facility as minimum pressure limiter.

DFC 27 B26, 43, 46, 52 F002 with external electrical locking as safety pressure limiter.

Additional information

Materials that come into contact with the medium:

Pressure sensor made of brass (DFC 17): brass, stainless steel, nitrile rubber.

Pressure sensor made of stainless steel (DFC 27): material No. 1.4104 and 1.4541

Error detection

- Regular operational checks must be performed in the installations.
- The frequency must be in accordance with local specifications or in accordance with the specifications of the owner-operator.
- If it is possible that the failure of a device could cause damage, additional protective systems / institutions must be implemented.

Additional technical data

Complies with:- Low-Voltage Directive 2006/95/EC	EN 60730-1 EN 60730-2-6	Electrical serviceable life for safety applications: $\cos\phi^1)= 0.6\dots 1$:	
EMC directive 2004/108/EC	EN 61000-6-1 EN 61000-6-2 EN 61000-6-3 EN 61000-6-4		DFC 17B, DFC 27B
PED 97/23/EC, Cat. IV (Pressure Equipment Directive) VdTÜV	Pressure information sheet 100 EN 12952-11 EN 12953-9	5,000 switchings ²⁾ 250,000 switchings ³⁾	2 A 0,6 A
		Mechanical serviceable life ²⁾ :	2×10^6 switch strokes

1) $\cos\phi = 0.3$ is not permitted
 2) Based on VD-TÜV paper 100, section 6.2.3
 3) Based on EN 12953.- / EN 12952-11, section 4.4.2.6

Technical notes

RC circuit under inductive load

For the optimum RC circuitry, refer to the specifications supplied by the manufacturers of the relays, contactors etc. If these are not available, the following rule of thumb can be applied in order to reduce the inductive load:-

- Capacitance of the RC circuit (μF) is equal to or greater than the operating current (A).
- Resistance of the RC circuit (Ω) is approx. equal to the resistance of the coil (Ω).

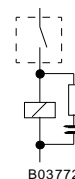

Wiring diagram

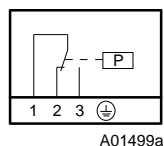

Dimension drawing

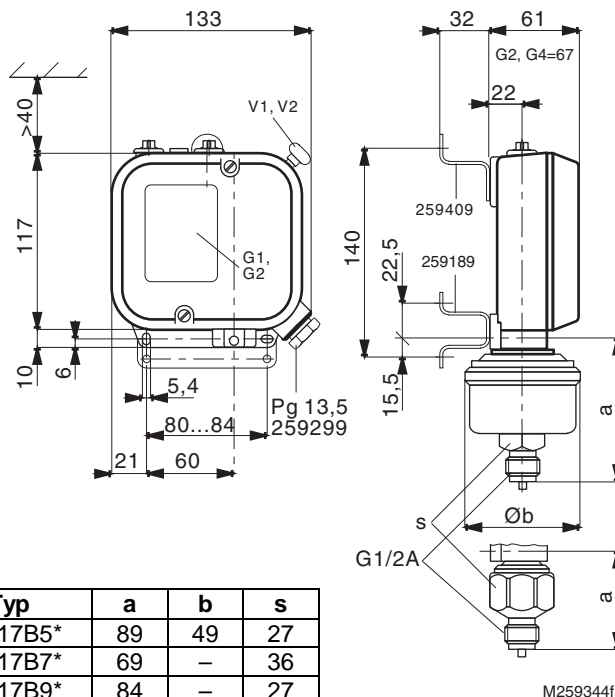

Typ	a	b	s
DFC 17B5*	89	49	27
DFC 17B7*	69	–	36
DFC 17B9*	84	–	27
DFC 27***	69	–	36

Accessories

192222

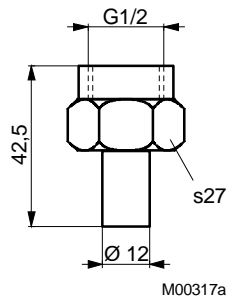

M00317a

259239

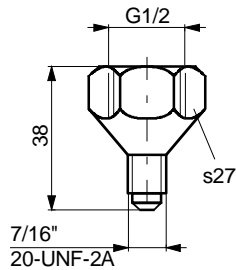

M00315

311572

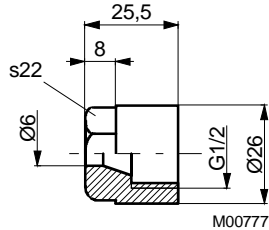

M00777

114467
192700

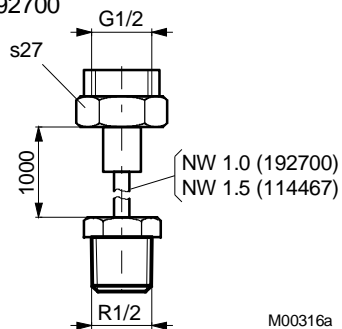

M00316a

259189

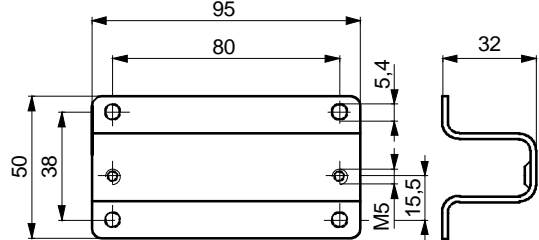

M00318

259409

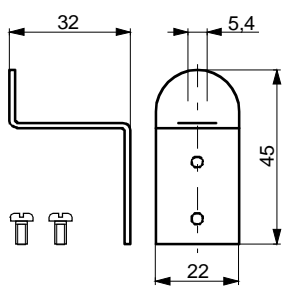

M00314

292018

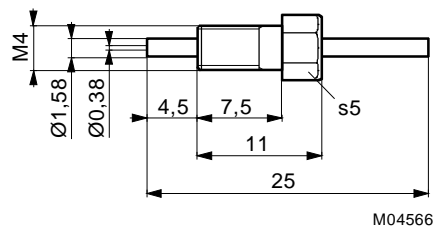

M04566

381141

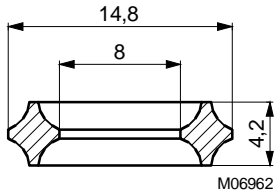

M06962